



Materials and Features

- ◆ The whole body is made of sand-casting aluminum, and with an iron pole inside which is treated with hot-dipped galvanized;
- ◆ Lampshade: Glass;
- ◆ Protection index: IP55;
- ◆ Recommended height: 3.9 M;
- ◆ Painting: Outdoor powder painting or fluorocarbon painting;
- ◆ Socket: E27;
- ◆ Lighting source: Energy saving, LED, or High pressure sodium lamp;
- ◆ Applicable places: Square, parks, garden, street;
- ◆ According to the requirements of the customers to provide tailor-made.

YAMP-G2012145



YAMP-G2012146

Materials and Features

- ◆ The whole body is made of sand-casting aluminum, and with an iron pole inside which is treated with hot-dipped galvanized;
- ◆ Lampshade: Glass or PMMA;
- ◆ Protection index: IP55;
- ◆ Recommended height: 3 M- 7 M;
- ◆ Painting: Outdoor powder painting or fluorocarbon painting;
- ◆ Socket: E27;
- ◆ Lighting source: Energy saving, LED, or High pressure sodium lamp;
- ◆ Applicable places: Square, parks, garden, street;
- ◆ According to the requirements of the customers to provide tailor-made.

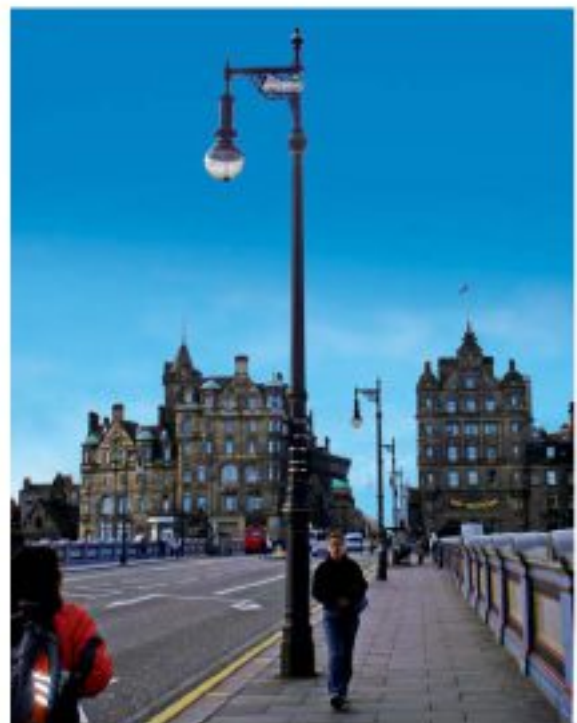

YAMP-G2012147

永安路燈 | YONGAN LIGHTING

Aluminum Courtyard Lighting Series



YAMP-G2012148



YAMP-G2012149

Materials and Features

- ◆ The whole body is made of sand-casting aluminum, and with an iron pole inside which is treated with hot-dipped galvanized;
- ◆ Lampshade: Glass or PMMA;
- ◆ Protection index: IP55;
- ◆ Recommended height: 2 M- 4 M;
- ◆ Painting: Outdoor powder painting or fluorocarbon painting;
- ◆ Socket: E27;
- ◆ Lighting source: Energy saving, LED, or High pressure sodium lamp;
- ◆ Applicable places: Square, parks, garden, street;
- ◆ According to the requirements of the customers to provide tailor-made.



YAMP-G2012150



YAMP-G2012151

Materials and Features

- ◆ The whole body is made of sand-casting aluminum, and with an iron pole inside which is treated with hot-dipped galvanized;
- ◆ Lampshade: Glass or PMMA;
- ◆ Protection index: IP55;
- ◆ Recommended height: 3 M- 5 M;
- ◆ Painting: Outdoor powder painting or fluorocarbon painting;
- ◆ Socket: E27;
- ◆ Lighting source: Energy saving, LED, or High pressure sodium lamp;
- ◆ Applicable places: Square, parks, garden, street;
- ◆ According to the requirements of the customers to provide tailor-made.



YAMP-G2012152



YAMP-G2012153



YAMP-G2012154



YAMP-G2012155

Materials and Features

- ◆ The whole body is made of sand-casting aluminum, and with an iron pole inside which is treated with hot-dipped galvanized;
- ◆ Lampshade: Glass or PMMA;
- ◆ Protection index: IP55;
- ◆ Recommended height: 3 M/9 M;
- ◆ Painting: Outdoor powder painting or fluorocarbon painting;
- ◆ Socket: E27;
- ◆ Lighting source: Energy saving, LED, or High pressure sodium lamp;
- ◆ Applicable places: Square, parks, garden, street;
- ◆ According to the requirements of the customers to provide tailor-made.

Materials and Features

- ◆ The whole body is made of sand-casting aluminum, and with an iron pole inside which is treated with hot-dipped galvanized;
- ◆ Lampshade: Glass or PMMA;
- ◆ Protection index: IP55;
- ◆ Recommended height: 3 M-5 M;
- ◆ Painting: Outdoor powder painting or fluorocarbon painting;
- ◆ Socket: E27;
- ◆ Lighting source: Energy saving, LED, or High pressure sodium lamp;
- ◆ Applicable places: Square, parks, garden, street;
- ◆ According to the requirements of the customers to provide tailor-made.



YAMP-G2012156



YAMP-G2012157



YAMP-G2012158



YAMP-G2012159

Materials and Features

- ◆ The whole body is made of sand-casting aluminum, and with an iron pole inside which is treated with hot-dipped galvanized;
- ◆ Lampshade: Glass or PMMA;
- ◆ Protection index: IP55;
- ◆ Recommended height: 3 M- 5 M;
- ◆ Painting: Outdoor powder painting or fluorocarbon painting;
- ◆ Socket: E27;
- ◆ Lighting source: Energy saving, LED, or High pressure sodium lamp;
- ◆ Applicable places: Square, parks, garden, street;
- ◆ According to the requirements of the customers to provide tailor-made.

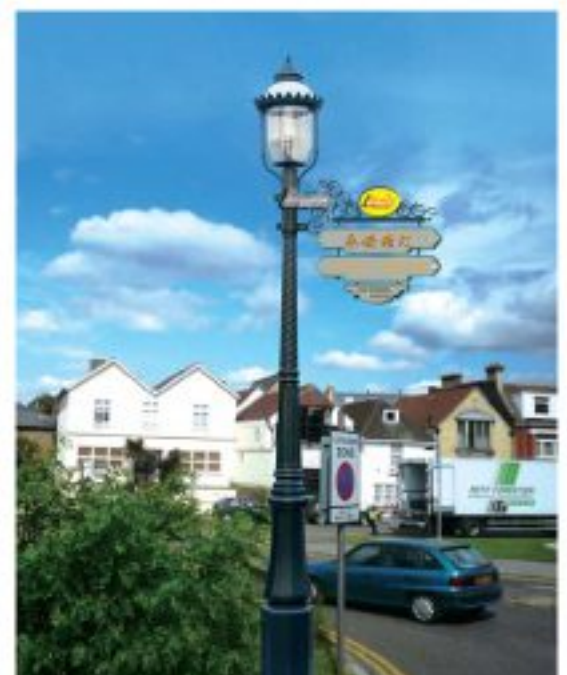

YAMP-G2012160

永安路灯 | YONGAN LIGHTING

Aluminum Courtyard Lighting Series



YAMP-G2012161



YAMP-G2012162

Materials and Features

- ◆ The whole body is made of sand-casting aluminum, and with an iron pole inside which is treated with hot-dipped galvanized;
- ◆ Lampshade: Glass or PMMA;
- ◆ Protection index: IP55;
- ◆ Recommended height: 3 M- 5 M;
- ◆ Painting: Outdoor powder painting or fluorocarbon painting;
- ◆ Socket: E27;
- ◆ Lighting source: Energy saving, LED, or High pressure sodium lamp;
- ◆ Applicable places: Square, parks, garden, street;
- ◆ According to the requirements of the customers to provide tailor-made.

YONGAN 永安路灯 | YONGAN LIGHTING
Courtyard Lighting Series



YONGAN

永安路灯

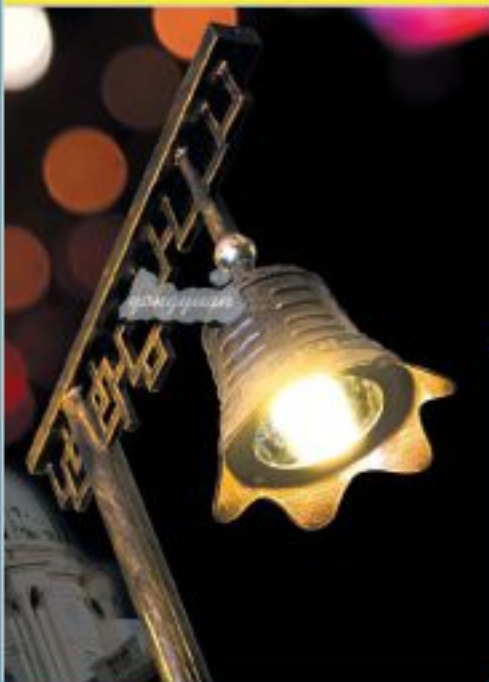



YAMP-H2012001

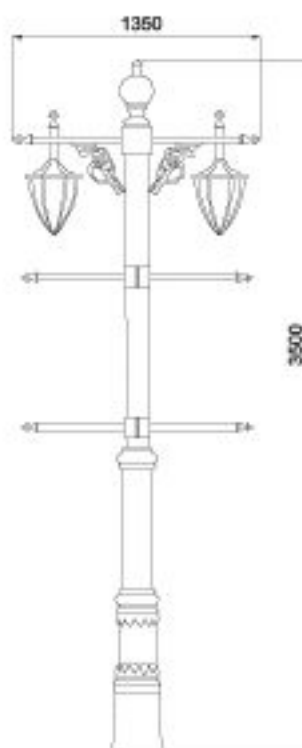

Materials and Features

- ◆ The pole is made of iron and treated with hot-dipped galvanized. The lantern is aluminum.
- ◆ Lampshade: Glass or PMMA;
- ◆ Protection Index: IP55;
- ◆ Recommended height: 3.5 M;
- ◆ Painting: Outdoor powder painting or fluorocarbon painting;
- ◆ Socket: E27;
- ◆ Lighting source: Energy saving, LED, or High pressure sodium lamp;
- ◆ Applicable places: Square, parks, garden, street;
- ◆ According to the requirements of the customers to provide tailor-made.



Materials and Features

- ◆ The pole is made of iron and treated with hot-dipped galvanized.
The lantern is aluminum.
- ◆ Lampshade: Glass;
- ◆ Protection index: IP55;
- ◆ Recommended height: 2.8 M;
- ◆ Painting: Outdoor powder painting or fluorocarbon painting;
- ◆ Socket: E27;
- ◆ Lighting source: Energy saving, LED, or High pressure sodium lamp;
- ◆ Applicable places: Square, parks, garden, street;
- ◆ According to the requirements of the customers to provide tailor-made.



YAMP-H2012002

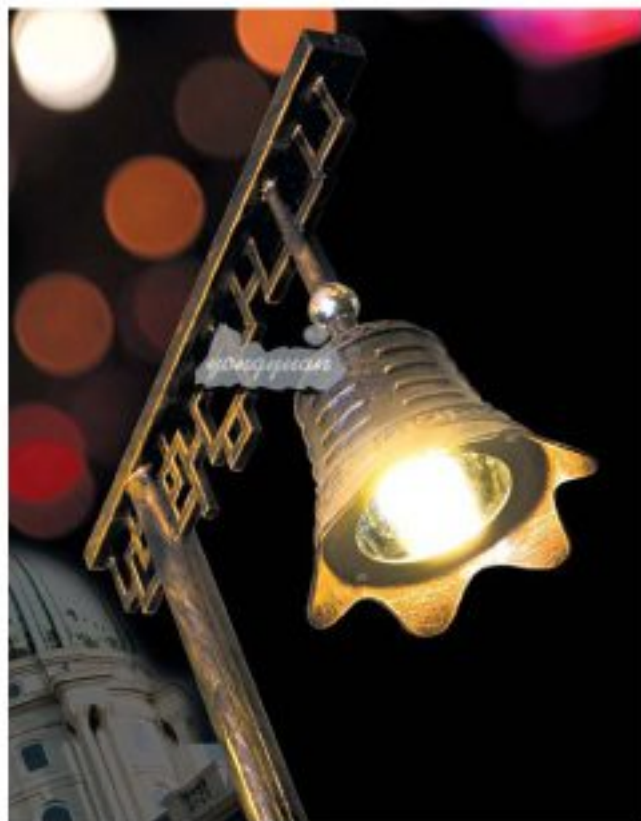

Materials and Features

- ◆ The pole is made of iron and treated with hot-dipped galvanized or stainless steel. The lantern is aluminum.
- ◆ Lampshade: Glass or PMMA;
- ◆ Protection index: IP55;
- ◆ Recommended height: 3.6 M;
- ◆ Painting: Outdoor powder painting or fluorocarbon painting;
- ◆ Socket: E27;
- ◆ Lighting source: Energy saving, LED, or High pressure sodium lamp;
- ◆ Applicable places: Square, parks, garden, street;
- ◆ According to the requirements of the customers to provide tailor-made.

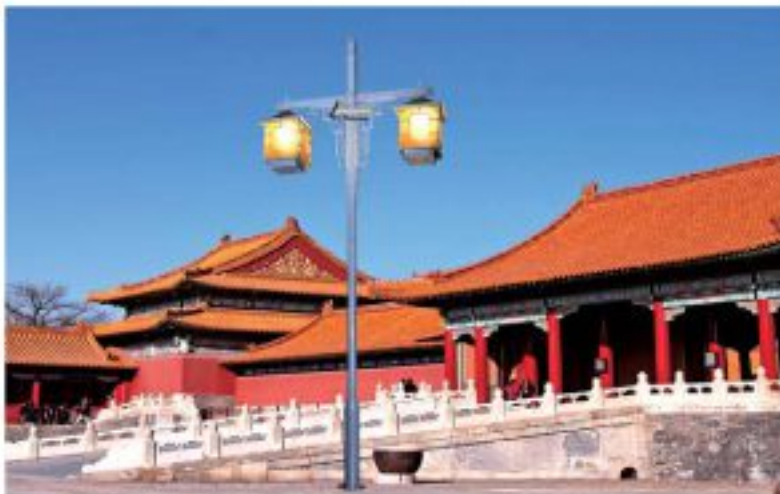
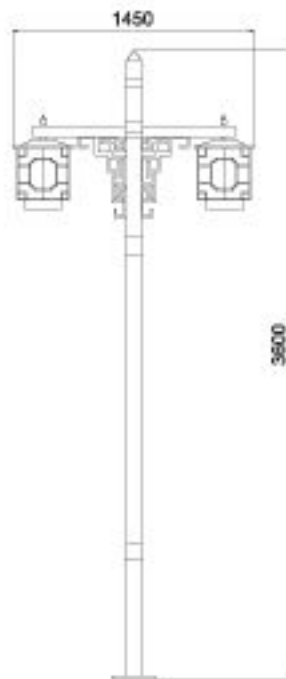

YAMP-H2012003



YAMP-H2012004

Materials and Features

- ◆ The pole is made of iron and treated with hot-dipped galvanized or aluminum. The lantern is aluminum.
- ◆ Lampshade: Glass or PMMA;
- ◆ Protection index: IP55;
- ◆ Recommended height: 3 M-5 M;
- ◆ Painting: Outdoor powder painting or fluorocarbon painting;
- ◆ Socket: E27;
- ◆ Lighting source: Energy saving, LED, or High pressure sodium lamp;
- ◆ Applicable places: Square, parks, garden, street;
- ◆ According to the requirements of the customers to provide tailor-made.

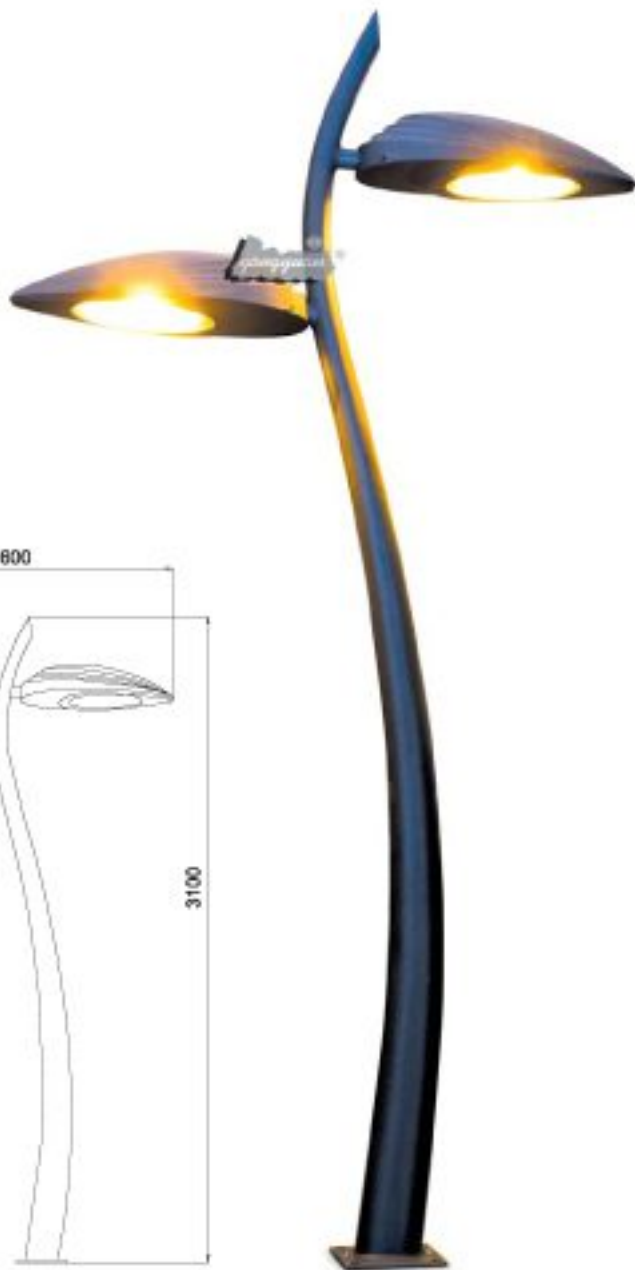
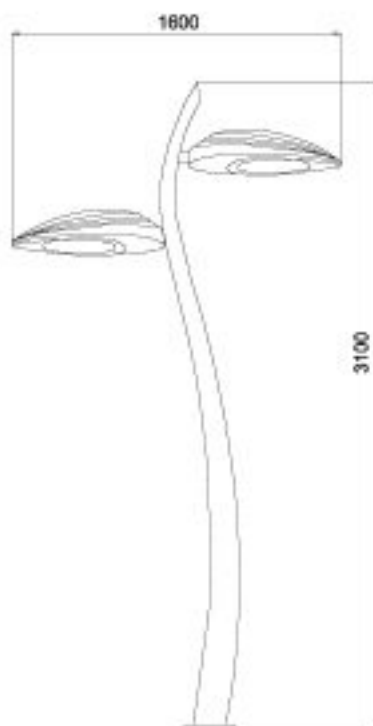

YAMP-H2012005

Materials and Features

- ◆ The whole body is made of aluminum.
- ◆ Lampshade: PMMA or PC;
- ◆ Protection index: IP55;
- ◆ Recommended height: 2.8 M-4M;
- ◆ Painting: Outdoor powder painting or fluorocarbon painting;
- ◆ Socket: E27;
- ◆ Lighting source: T4 or LED;
- ◆ Applicable places: Square, parks, garden, street;
- ◆ According to the requirements of the customers to provide tailor-made.

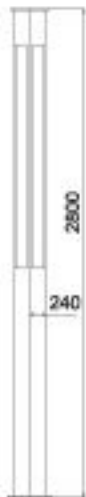

YAMP-H2012006



YAMP-H2012007



YAMP-H2012008

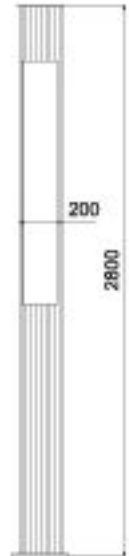

 **永安路燈** | **YONGAN LIGHTING**
 Courtyard Lighting Series



YAMP-H2012009

Materials and Features

- ◆ The pole is made of iron and treated with hot-dipped galvanized.
The lantern is aluminum.
- ◆ Lampshade: PMMA or PC;
- ◆ Protection index: IP55;
- ◆ Recommended height: 2.8 M-4 M;
- ◆ Painting: Outdoor powder painting or fluorocarbon painting;
- ◆ Socket: E27;
- ◆ Lighting source: Energy saving, LED, or High pressure sodium lamp;
- ◆ Applicable places: Square, parks, garden, street;
- ◆ According to the requirements of the customers to provide tailor-made.



YAMP-H2012011



YAMP-H2012010



YAMP-H2012012



YAMP-H2012013

Materials and Features

- ◆ The pole is made of iron and treated with hot-dipped galvanized.
The lantern is aluminum.
- ◆ Lampshade: Glass or PMMA;
- ◆ Protection index: IP55;
- ◆ Recommended height: 2.8 M-4 M;
- ◆ Painting: Outdoor powder painting or fluorocarbon painting;
- ◆ Socket: E27;
- ◆ Lighting source: Energy saving, LED, or High pressure sodium lamp;
- ◆ Applicable places: Square, parks, garden, street;
- ◆ According to the requirements of the customers to provide tailor-made.



Materials and Features

- ◆ The body is made of aluminum.
- ◆ Lampshade: Glass or PMMA;
- ◆ Protection index: IP55;
- ◆ Recommended height: 2.8 M-4 M;
- ◆ Painting: Outdoor powder painting or fluorocarbon painting;
- ◆ Socket: E27;
- ◆ Lighting source: Energy saving, LED, or High pressure sodium lamp;
- ◆ Applicable places: Square, parks, garden, street;
- ◆ According to the requirements of the customers to provide tailor-made.

YAMP-H2012014



Materials and Features

- ◆ The pole is made of iron and treated with hot-dipped galvanized.
The lantern is aluminum.
- ◆ Lampshade: Glass or PMMA;
- ◆ Protection index: IP55;
- ◆ Recommended height: 2.8 M-4 M;
- ◆ Painting: Outdoor powder painting or fluorocarbon painting;
- ◆ Socket: E27;
- ◆ Lighting source: Energy saving, LED, or High pressure sodium lamp;
- ◆ Applicable places: Square, parks, garden, street;
- ◆ According to the requirements of the customers to provide tailor-made.



YAMP-H2012015

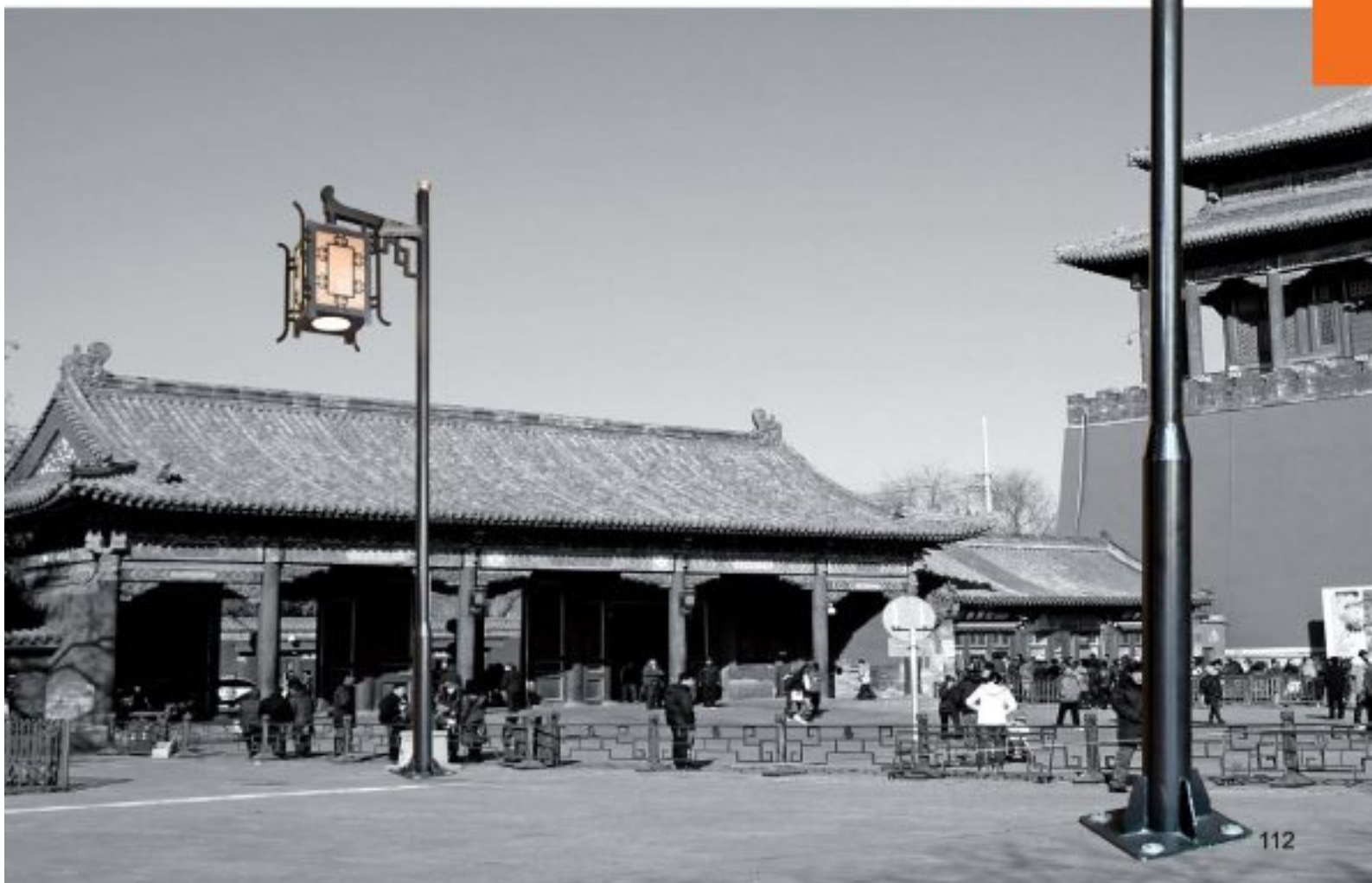



YAMP-H2012016



YAMP-H2012017

Materials and Features

- ◆ The pole is made of iron and treated with hot-dipped galvanized. The lantern is aluminum.
- ◆ Lampshade: Glass;
- ◆ Protection index: IP55;
- ◆ Recommended height: 3 M-5 M;
- ◆ Painting: Outdoor powder painting or fluorocarbon painting;
- ◆ Socket: E27;
- ◆ Lighting source: Energy saving, LED, or High pressure sodium lamp;
- ◆ Applicable places: Square, parks, garden, street;
- ◆ According to the requirements of the customers to provide tailor-made.



YAMP-H2012018

Materials and Features

- ◆ The pole is made of iron and treated with hot-dipped galvanized. The lantern is aluminum.
- ◆ Lampshade: Glass or PMMA;
- ◆ Protection index: IP55;
- ◆ Recommended height: 2.8 M-4 M;
- ◆ Painting: Outdoor powder painting or fluorocarbon painting;
- ◆ Socket: E27;
- ◆ Lighting source: Energy saving, LED, or High pressure sodium lamp;
- ◆ Applicable places: Square, parks, garden, street;
- ◆ According to the requirements of the customers to provide tailor-made.



YAMP-H2012019



YAMP-H2012020



YAMP-H2012022



YAMP-H2012021

Materials and Features

- ◆ The pole is made of iron and treated with hot-dipped galvanized. The lantern is aluminum.
- ◆ Lampshade: Glass or PMMA;
- ◆ Protection index: IP55;
- ◆ Recommended height: 3 M-5 M;
- ◆ Painting: Outdoor powder painting or fluorocarbon painting;
- ◆ Socket: E27;
- ◆ Lighting source: Energy saving, LED, or High pressure sodium lamp;
- ◆ Applicable places: Square, parks, garden, street;
- ◆ According to the requirements of the customers to provide tailor-made.



YAMP-H2012023



YAMP-H2012024

Materials and Features

- ◆ The pole is made of iron and treated with hot-dipped galvanized. The lantern is aluminum or stainless steel.
- ◆ Lampshade: Glass or PMMA;
- ◆ Protection index: IP55;
- ◆ Recommended height: 3 M-6 M;
- ◆ Painting: Outdoor powder painting or fluorocarbon painting;
- ◆ Socket: E27;
- ◆ Lighting source: Energy saving, LED, or High pressure sodium lamp;
- ◆ Applicable places: Square, parks, garden, street;
- ◆ According to the requirements of the customers to provide tailor-made.





YAMP-H2012025



YAMP-H2012026

永安路灯 | YONGAN LIGHTING

Courtyard Lighting Series



YAMP-H2012027

Materials and Features

- ◆ The pole is made of iron and treated with hot-dipped galvanized. The lantern is aluminum.
- ◆ Lampshade: Glass or PMMA;
- ◆ Protection Index: IP55;
- ◆ Recommended height: 2.8 M-4 M;
- ◆ Painting: Outdoor powder painting or fluorocarbon painting;
- ◆ Socket: E27;
- ◆ Lighting source: Energy saving, LED, or High pressure sodium lamp;
- ◆ Applicable places: Square, parks, garden, street;
- ◆ According to the requirements of the customers to provide tailor-made.

永安路灯 | YONGAN LIGHTING

Courtyard Lighting Series

Materials and Features

- ◆ The pole is made of iron and treated with hot-dipped galvanized.
The lantern is aluminum.
- ◆ Lampshade: Glass or PMMA;
- ◆ Protection index: IP55;
- ◆ Recommended height: 2.8 M-4 M;
- ◆ Painting: Outdoor powder painting or fluorocarbon painting;
- ◆ Socket: E27;
- ◆ Lighting source: Energy saving, LED, or High pressure sodium lamp;
- ◆ Applicable places: Square, parks, garden, street;
- ◆ According to the requirements of the customers to provide tailor-made.



YAMP-H2012028



YAMP-H2012029



YAMP-H2012030



YAMP-H2012031

Materials and Features

- ◆ The pole is made of iron and treated with hot-dipped galvanized. The lantern is aluminum.
- ◆ Lampshade: Glass or PMMA;
- ◆ Protection index: IP55;
- ◆ Recommended height: 2.8 M-4 M;
- ◆ Painting: Outdoor powder painting or fluorocarbon painting;
- ◆ Socket: E27;
- ◆ Lighting source: Energy saving, LED, or High pressure sodium lamp;
- ◆ Applicable places: Square, parks, garden, street;
- ◆ According to the requirements of the customers to provide tailor-made.

永安路灯 | YONGAN LIGHTING

Courtyard Lighting Series

Materials and Features

- ◆ The pole is made of iron and treated with hot-dipped galvanized.
The lantern is aluminum.
- ◆ Lampshade: Glass or PMMA;
- ◆ Protection index: IP55;
- ◆ Recommended height: 2.8 M-4 M;
- ◆ Painting: Outdoor powder painting or fluorocarbon painting;
- ◆ Socket: E27;
- ◆ Lighting source: Energy saving, LED, or High pressure sodium lamp;
- ◆ Applicable places: Square, parks, garden, street;
- ◆ According to the requirements of the customers to provide tailor-made.



YAMP-H2012032



YAMP-H2012033



YAMP-H2012034

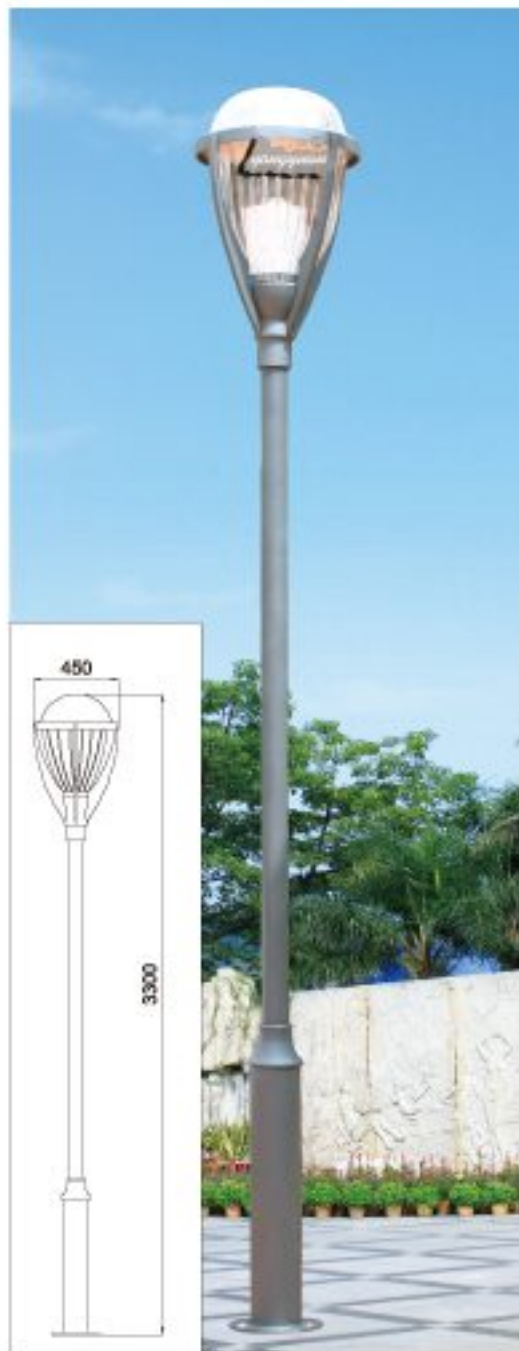

YAMP-H2012035

Materials and Features

- ◆ The pole is made of iron and treated with hot-dipped galvanized. The lantern is aluminum.
- ◆ Lampshade: Glass or PMMA;
- ◆ Protection index: IP55;
- ◆ Recommended height: 2.8 M-4 M;
- ◆ Painting: Outdoor powder painting or fluorocarbon painting;
- ◆ Socket: E27;
- ◆ Lighting source: Energy saving, LED, or High pressure sodium lamp;
- ◆ Applicable places: Square, parks, garden, street;
- ◆ According to the requirements of the customers to provide tailor-made.



YAMP-H2012036



YAMP-H2012037

Materials and Features

- ◆ The pole is made of iron and treated with hot-dipped galvanized. The lantern is aluminum.
- ◆ Lampshade: Glass or PMMA;
- ◆ Protection index: IP55;
- ◆ Recommended height: 2.8 M-7 M;
- ◆ Painting: Outdoor powder painting or fluorocarbon painting;
- ◆ Socket: E27;
- ◆ Lighting source: Energy saving, LED, or High pressure sodium lamp;
- ◆ Applicable places: Square, parks, garden, street;
- ◆ According to the requirements of the customers to provide tailor-made.



YAMP-H2012038

 永安路灯 | YONGAN LIGHTING

Courtyard Lighting Series

Materials and Features

- ◆ The pole is made of iron and treated with hot-dipped galvanized. The lantern is aluminum.
- ◆ Lampshade: Glass or PMMA;
- ◆ Protection index: IP55;
- ◆ Recommended height: 4 M;

- ◆ Painting: Outdoor powder painting or fluorocarbon painting;
- ◆ Socket: E27;
- ◆ Lighting source: Energy saving or LED.
- ◆ Applicable places: Square, parks, garden, street;
- ◆ According to the requirements of the customers to provide tailor-made.



YAMP-H2012039



YAMP-H2012040

永安路灯 | YONGAN LIGHTING

Courtyard Lighting Series

Materials and Features

- ◆ The pole is made of iron and treated with hot-dipped galvanized.
The lantern is aluminum.
- ◆ Lampshade: Glass or PMMA;
- ◆ Protection index: IP55;
- ◆ Recommended height: 3 M-6 M;
- ◆ Painting: Outdoor powder painting or fluorocarbon painting;
- ◆ Socket: E27;
- ◆ Lighting source: Energy saving, LED, or High pressure sodium lamp;
- ◆ Applicable places: Square, parks, garden, street;
- ◆ According to the requirements of the customers to provide tailor-made.



YAMP-H2012041



YAMP-H2012042

Materials and Features

- ◆ The pole is made of iron and treated with hot-dipped galvanized.
The lantern is aluminum.
- ◆ Lampshade: Glass or PC;
- ◆ Protection index: IP55;
- ◆ Recommended height: 3 M-5 M;
- ◆ Painting: Outdoor powder painting or fluorocarbon painting;
- ◆ Socket: E27;
- ◆ Lighting source: Energy saving, LED, or High pressure sodium lamp;
- ◆ Applicable places: Square, parks, garden, street;
- ◆ According to the requirements of the customers to provide tailor-made.



YAMP-H2012043



YAMP-H2012044



YAMP-H2012045

Materials and Features

- ◆ The pole is made of iron and treated with hot-dipped galvanized.
The lantern is aluminum.
- ◆ Lampshade: Glass or PC;
- ◆ Protection index: IP55;
- ◆ Recommended height: 3 M-5 M;
- ◆ Painting: Outdoor powder painting or fluorocarbon painting;
- ◆ Socket: E27;
- ◆ Lighting source: Energy saving, LED, or High pressure sodium lamp;
- ◆ Applicable places: Square, parks, garden, street;
- ◆ According to the requirements of the customers to provide tailor-made.



YAMP-H2012046



YAMP-H2012047

永安路灯 | YONGAN LIGHTING Courtyard Lighting Series

Materials and Features

- ◆ The pole is made of iron and treated with hot-dipped galvanized.
The lantern is aluminum.
- ◆ Lampshade: Glass;
- ◆ Protection index: IP55;
- ◆ Recommended height: 3 M-5 M;
- ◆ Painting: Outdoor powder painting or fluorocarbon painting;
- ◆ Socket: E27;
- ◆ Lighting source: Energy saving, LED, or High pressure sodium lamp;
- ◆ Applicable places: Square, parks, garden, street;
- ◆ According to the requirements of the customers to provide tailor-made.



YAMP-H2012048



YAMP-H2012049

Materials and Features

- ◆ The pole is made of iron and treated with hot-dipped galvanized. The lantern is aluminum.
- ◆ Lampshade: PC;
- ◆ Protection index: IP55;
- ◆ Recommended height: 3 M-5 M;
- ◆ Painting: Outdoor powder painting or fluorocarbon painting;
- ◆ Socket: E27;
- ◆ Lighting source: Energy saving, LED, or High pressure sodium lamp;
- ◆ Applicable places: Square, parks, garden, street;
- ◆ According to the requirements of the customers to provide tailor-made.



YAMP-H2012050



永安路灯 | YONGAN LIGHTING Courtyard Lighting Series

Materials and Features

- ◆ The pole is made of iron and treated with hot-dipped galvanized. The lantern is aluminum.
- ◆ Lampshade: PC;
- ◆ Protection index: IP55;
- ◆ Recommended height: 3 M-5 M;
- ◆ Painting: Outdoor powder painting or fluorocarbon painting;

- ◆ Socket: E27;
- ◆ Lighting source: Energy saving, LED, or High pressure sodium lamp;
- ◆ Applicable places: Square, parks, garden, street;
- ◆ According to the requirements of the customers to provide tailor-made.



YAMP-H2012051

Materials and Features

- ◆ The pole is made of iron and treated with hot-dipped galvanized. The lantern is aluminum.
- ◆ Lampshade: PC;
- ◆ Protection index: IP55;
- ◆ Recommended height: 3 M-5 M;
- ◆ Painting: Outdoor powder painting or fluorocarbon painting;
- ◆ Socket: E27;
- ◆ Lighting source: Energy saving, LED, or High pressure sodium lamp;
- ◆ Applicable places: Square, parks, garden, street;
- ◆ According to the requirements of the customers to provide tailor-made.



YAMP-H2012052



YAMP-H2012053



YAMP-H2012054



永安路灯 | YONGAN LIGHTING

Courtyard Lighting Series

Materials and Features

- ◆ The pole is made of iron and treated with hot-dipped galvanized. The lantern is aluminum.
- ◆ Lampshade: Glass, PMMA or PC;
- ◆ Protection Index: IP55;
- ◆ Recommended height: 3 M-5 M;
- ◆ Painting: Outdoor powder painting or fluorocarbon painting;
- ◆ Socket: E27;
- ◆ Lighting source: Energy saving, LED, or High pressure sodium lamp;
- ◆ Applicable places: Square, parks, garden, street;
- ◆ According to the requirements of the customers to provide tailor-made.



YAMP-H2012055



YAMP-H2012056



永安路灯 | YONGAN LIGHTING

Courtyard Lighting Series

Materials and Features

- ◆ The pole is made of iron and treated with hot-dipped galvanized. The lantern is aluminum.
- ◆ Lampshade: Glass or PMMA;
- ◆ Protection index: IP55;
- ◆ Recommended height: 3 M-5 M;
- ◆ Painting: Outdoor powder painting or fluorocarbon painting;
- ◆ Socket: E27;
- ◆ Lighting source: Energy saving, LED, or High pressure sodium lamp;
- ◆ Applicable places: Square, parks, garden, street;
- ◆ According to the requirements of the customers to provide tailor-made.

 永安路燈 | YONGAN LIGHTING
Garden Light Series



Wall Light Series

LED Series





YAMP-H2012057

Materials and Features

- ◆ The pole is made of iron and treated with hot-dipped galvanized. The lantern is aluminum.
- ◆ Lampshade: Glass or PMMA;
- ◆ Protection index: IP55;
- ◆ Recommended height: 3 M-5 M;
- ◆ Painting: Outdoor powder painting or fluorocarbon painting;
- ◆ Socket: E27;
- ◆ Lighting source: Energy saving, LED, or High pressure sodium lamp;
- ◆ Applicable places: Square, parks, garden, street;
- ◆ According to the requirements of the customers to provide tailor-made.



YAMP-H2012058

Materials and Features

- ◆ The pole is made of iron and treated with hot-dipped galvanized. The lantern is aluminum.
- ◆ Lampshade: PC;
- ◆ Protection index: IP55;
- ◆ Recommended height: 3 M-5 M;
- ◆ Painting: Outdoor powder painting or fluorocarbon painting;
- ◆ Socket: E27;
- ◆ Lighting source: Energy saving, LED, or High pressure sodium lamp;
- ◆ Applicable places: Square, parks, garden, street;
- ◆ According to the requirements of the customers to provide tailor-made.



YAMP-H2012059



YAMP-H2012060

Materials and Features

- ◆ The pole is made of iron and treated with hot-dipped galvanized. The lantern is aluminum.
- ◆ Lampshade: Glass or PMMA;
- ◆ Protection index: IP55;
- ◆ Recommended height: 2.8 M-5 M;
- ◆ Painting: Outdoor powder painting or fluorocarbon painting;
- ◆ Socket: E27;
- ◆ Lighting source: Energy saving, LED, or High pressure sodium lamp;
- ◆ Applicable places: Square, parks, garden, street;
- ◆ According to the requirements of the customers to provide tailor-made.

永安路灯 | YONGAN LIGHTING Courtyard Lighting Series



YAMP-H2012061

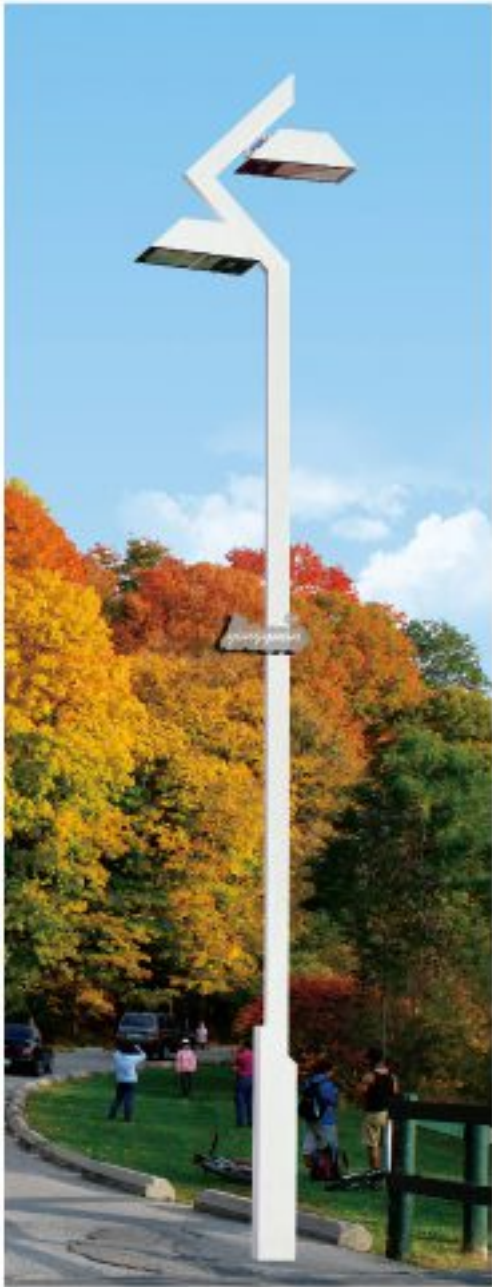

YAMP-H2012062



YAMP-H2012063

Materials and Features

- ◆ The pole is made of iron and treated with hot-dipped galvanized. The lantern is aluminum.
- ◆ Lampshade: Glass or PMMA;
- ◆ Protection index: IP55;
- ◆ Recommended height: 3 M-5 M;
- ◆ Painting: Outdoor powder painting or fluorocarbon painting;
- ◆ Socket: E27;
- ◆ Lighting source: Energy saving, LED, or High pressure sodium lamp;
- ◆ Applicable places: Square, parks, garden, street;
- ◆ According to the requirements of the customers to provide tailor-made.

永安路灯 | YONGAN LIGHTING

Courtyard Lighting Series



YAMP-H2012064

Materials and Features

- ◆ The pole is made of iron and treated with hot-dipped galvanized. The lantern is aluminum.
- ◆ Lampshade: Glass or PMMA;
- ◆ Protection index: IP55;
- ◆ Recommended height: 3 M-6 M;
- ◆ Painting: Outdoor powder painting or fluorocarbon painting;
- ◆ Socket: E27;
- ◆ Lighting source: Energy saving, LED, or High pressure sodium lamp;
- ◆ Applicable places: Square, parks, garden, street;
- ◆ According to the requirements of the customers to provide tailor-made.



YAMP-H2012065



YAMP-H2012066



YAMP-H2012067



YAMP-M2012001

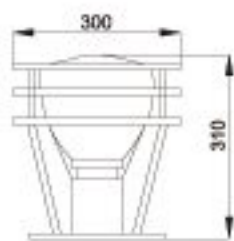

YAMP-M2012002



YAMP-M2012003

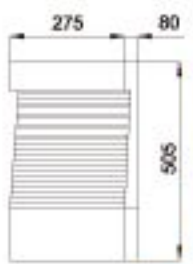
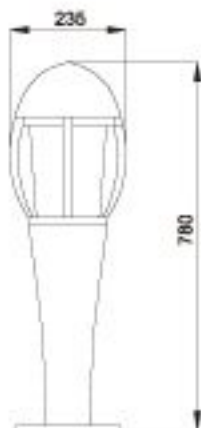

YAMP-M2012004